

SKYCORE FAMILY

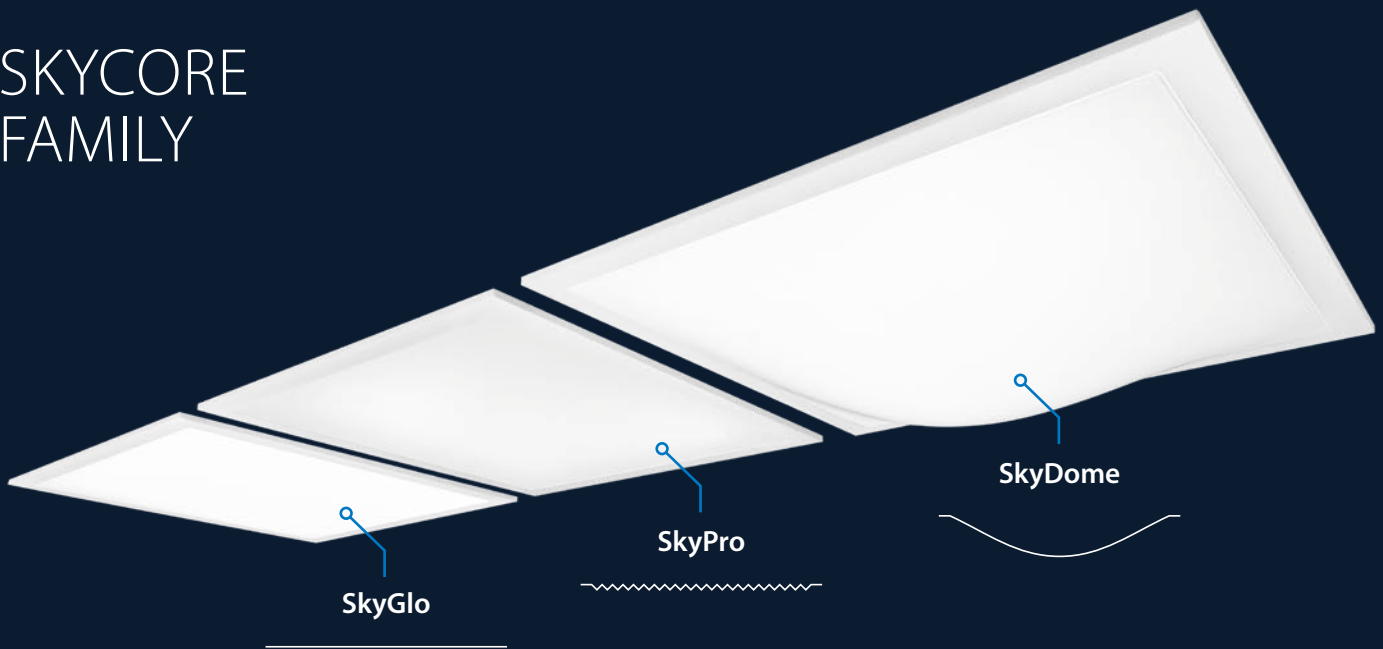

EMERGENCY TYPE ♦	PRODUCT CODE	WATTAGE	MOUNTING OPTIONS	SIZE	CONTROL TYPE
W SmartScan*	SG SkyGlo	16 16W	R Recessed	M 600 x 600	S SmartScan
T AutoTest**		24 24W	S Surface		A Dimming (DALI)
E Emergency**		30 30W	P Pendant		L Non-dimming
		34 34W			

E.g. WSG16RMS

W SmartScan	SG SkyGlo	16 16W	R Recessed	M 600 x 600	S SmartScan
--------------------	------------------	---------------	-------------------	--------------------	--------------------

♦ Optional, leave blank if emergency is not required

* Only available with S or L control type

** Not available with S control type

WEIGHTS

SIZE	APPROX. kg
Recessed	4.6
Surface/Suspended	8.8

EMERGENCY

Add 0.3kg to weight listed.

SMARTSCAN

Add 0.2kg to weight listed.

PHOTOMETRIC GUIDE

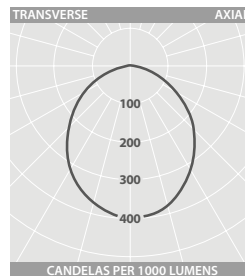

Luminaire Lumen Output
 16W = 2755lm
 24W = 3820lm
 30W = 4830lm
 34W = 5410lm

ACCESSORIES

DESCRIPTION	CAT. No.
Optional side arm suspension kit ▲	IK 20277
Recessing frame for plasterboard ceiling	RAD16877

▲ 4 arms per kit - not required for lay-in mounting

WEB LINK >
 "PLUG AND PLAY"
 LIGHTING CABLE
 MANAGEMENT



OPAL POLYCARBONATE DIFFUSER LUMINAIRES



SPECIFICATION

- Steel body finished full polyester non-yellowing white (RAL9016)
- Shallow body depth of 59mm, 94mm including the gearbox
- Supplied with opal polycarbonate TP(a) fire-retardant diffuser
- Suitable for most ceiling types with optional side arm suspensions and plasterboard mounting kits
- Designed to exclude dust, dirt and flies. All control gear is outside the lamp enclosure
- SmartScan wireless technology removes the need for control cabling. Ideal for retro-fit
- Rapid installation using Fast-Fix wiring enclosure or SmartScan plug and play TEE connectors
- Wattage selectable during installation. Please see photometric guide for options and lumen output
- Fitted with 4000K LEDs

SmartScan Configurations



Find out more at www.thorlux.com/smartsan

LED CHARACTERISTICS

CRI	80+
COLOUR TEMPERATURE	4000K
RATED LIFE (HOURS)	100K - L80/B10
PROTECTION	LUX GUARD
DRIVER EFFICIENCY	>87%
REPLACEABLE	YES
POWER FACTOR	>0.95

LL/CW 146.9

For LED characteristics explanation see www.thorlux.com/led-guide



DIMENSIONS

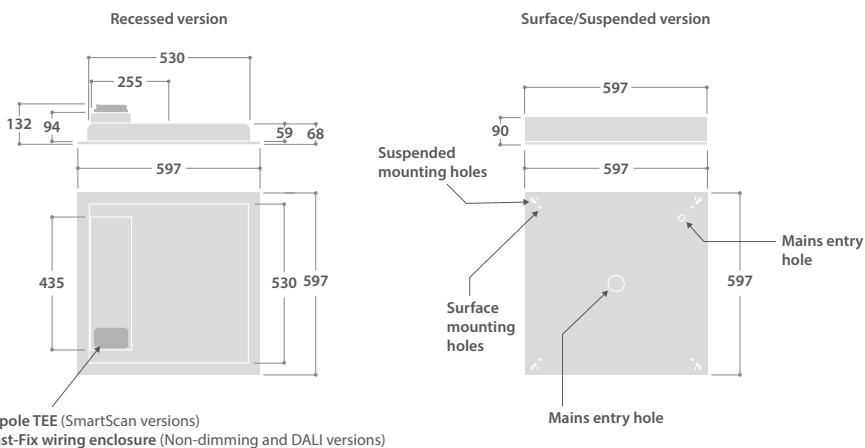

SKYGLO

Recessed



Surface



Pendant

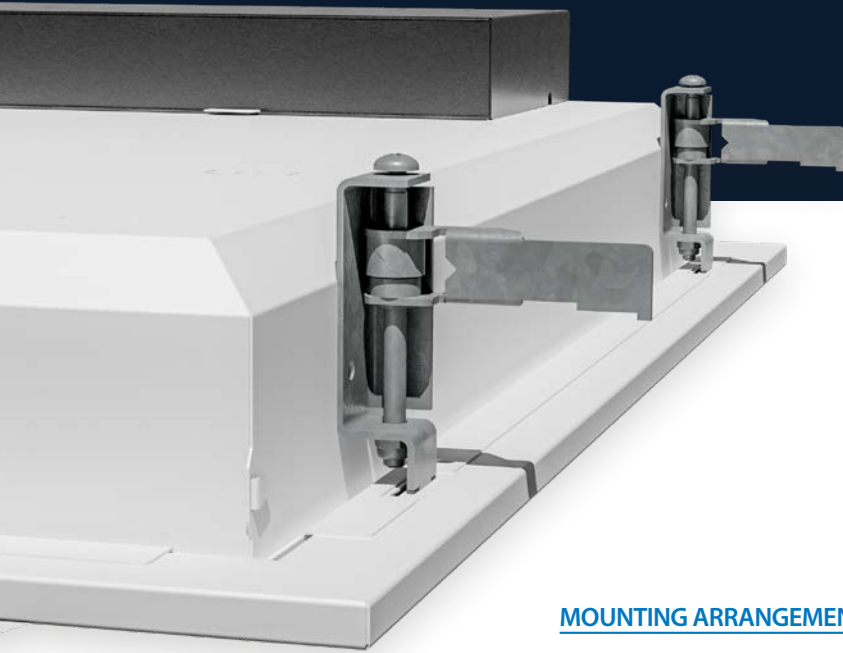
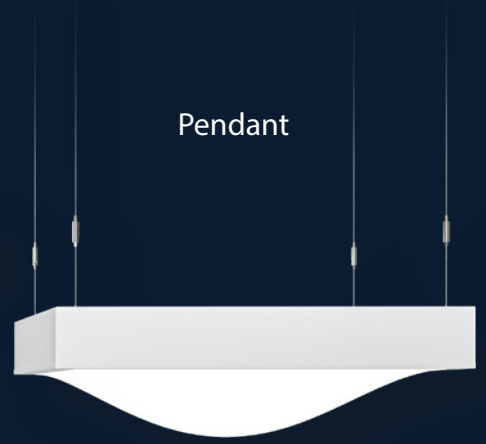

MOUNTING ARRANGEMENTS

Exposed T bar

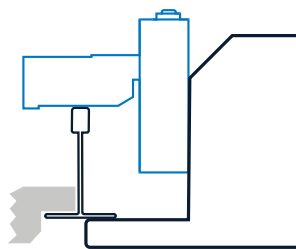

NOTE: - Side arm suspension kit to be ordered separately.

Spring Tee

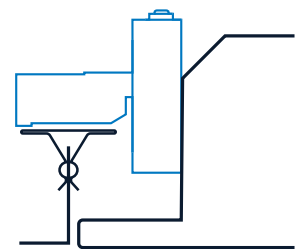

NOTE: - Side arm suspension kit to be ordered separately.

Lay-in on
exposed
T bar

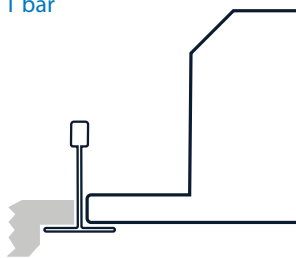

Plasterboard ceiling
with recessing frame

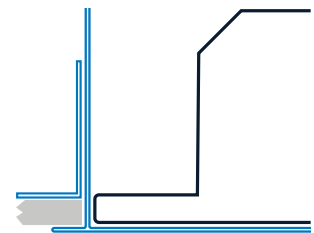

NOTE: - Plasterboard recessing frame to be ordered separately.