

NEMO_{STUDIO}

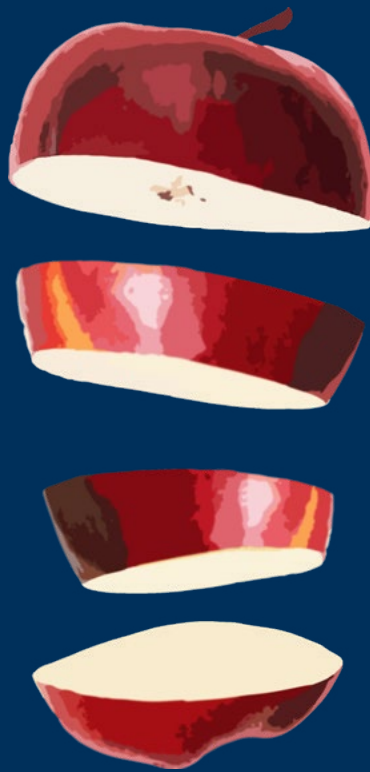

GRAVITY

2022



ENG

GRAVITY is the new magnetic system of FLEX collection. A versatile and distinctive galaxy of graphical elements capable of enhancing any environment and providing a focal lighting effect. Installed magnetically with an extra mechanical security feature. Offered for trimless, ceiling and pendant mounting, linear units use a 48V power supply and allow the integration of multiple solutions, installed through magnetic and mechanical fixing, meeting different interior needs. Adjustable spots emphasise any setting due to maximum flexibility and the anti-glare retracted lens for accent or diffuse lighting. Linear modules are proposed with an opal screen for homogeneous and welcoming lighting. For high visual comfort and optimal glare control over the entire surface, the system is completed by UGR<19 units: recessed or fold, respectively for direct or adjustable light emission. GRAVITY can be installed individually or in multiple configurations, creating geometric figures with 90° angles.

ITA

GRAVITY è il nuovo sistema magnetico della collezione FLEX. Una galassia di elementi grafici versatili e distintivi in grado di valorizzare ogni ambiente e fornire un effetto luminoso focale. Installato in modo magnetico e dotato di una sicurezza supplementare meccanica. Disponibile nelle versioni trimless, a soffitto e a sospensione, le unità lineari si alimentano a 48V e consentono l'integrazione di più soluzioni, installate tramite fissaggio magnetico e meccanico, rispondendo alle diverse esigenze d'interni. La massima flessibilità degli spot orientabili valorizza gli ambienti e la lente antiriflesso arretrata permette di ottenere un'illuminazione d'accento o diffusa. I moduli lineari presentano uno schermo opalino per un'illuminazione omogenea e accogliente. Per un elevato comfort visivo e un controllo ottimale dell'abbagliamento su tutta la superficie, il sistema è completato da unità UGR<19: recessed o fold, rispettivamente per un'emissione di luce diretta o orientabile. GRAVITY può essere installato singolarmente o in configurazioni multiple, creando figure geometriche con angoli di 90°.

DEU

GRAVITY ist das neue Magnetsystem von FLEX COLLECTION. Eine vielseitige und unverwechselbare Galaxie von Gestaltungselementen, die jede Umgebung aufwertet und einen besonderen Lichteffekt bietet. Die Montage der Leuchten erfolgt magnetisch mit einer mechanischen Zusatzsicherung. Die Magnetschienen, die für den rahmenlose Einbau, als Anbau- und Pendelmontage angeboten werden, werden mit 48 V eingespeist und ermöglichen die Integration zahlreicher Leuchten Module, die sowohl magnetisch als auch mechanisch befestigt werden können, um den unterschiedlichen Anforderungen der Räume gerecht zu werden. Die verstellbaren Spots sorgen für ein Maximum an Flexibilität und die blendfreie Linse für eine akzentuierte oder diffuse Beleuchtung und unterstreichen so jede Umgebung. Für eine homogene und angenehme Beleuchtung werden lineare Module mit opaler Abdeckung angeboten. Das System wird für einen hohen Sehkomfort und optimale Blendungsbegrenzung auf der gesamten Fläche durch UGR<19 Elemente vervollständigt: versenkt oder schwenkbar, für eine direkte oder variable Beleuchtung. GRAVITY kann einzeln oder in vielfältigen Varianten installiert werden, wobei geometrische Figuren mit 90°-Winkeln entstehen.

FR

GRAVITY est le nouveau système magnétique de la collection FLEX. Une galaxie d'éléments graphiques polyvalents et distinctifs capables d'améliorer n'importe quel environnement et de fournir un effet lumineux focal. Installé magnétiquement et équipé d'une sécurité mécanique supplémentaire. Disponibles en version trimless, en saillie et suspendue, les unités linéaires sont alimentées à 48V et permettent l'intégration de multiples solutions, installées par fixation magnétique et mécanique, répondant aux différents besoins intérieurs. La flexibilité maximale des spots orientables met en valeur les espaces et la lentille encastrée anti-éblouissement permet un éclairage d'accentuation ou diffus. Les modules linéaires sont dotés d'un écran opale pour un éclairage homogène et accueillant. Pour un confort visuel élevé et un contrôle optimal de l'éblouissement sur toute la surface, le système est complété par des unités UGR <19: recessed ou fold, respectivement pour une émission lumineuse directe ou orientable. GRAVITY peut être installé individuellement ou dans de multiples configurations, créant des figures géométriques avec des angles de 90°.

SPOT 3W

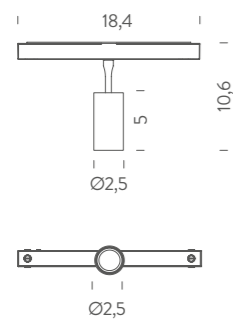

SPOT 8W

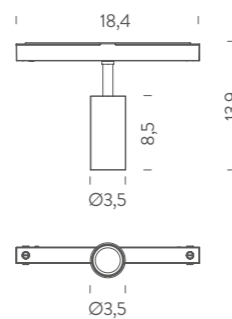

SPOT 12W

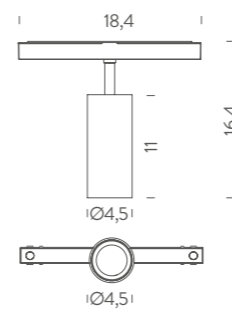

SPOT

3W

CCT	max power	optic	emission	voltage	lum. flux	CRI	switching	code	finish	Euro
2700K	3W	38°	orientable	48V	137lm	90	DALI	MFLE5201746DAN	black	227,00
3000K	3W	38°	orientable	48V	185lm	90	DALI	MFLE5201746WAN	black	227,00

8W

2700K	8W	15°	orientable	48V	415lm	90	DALI	MFLE5201344DAN	black	270,00
2700K	8W	38°	orientable	48V	597lm	90	DALI	MFLE5201744DAN	black	270,00
3000K	8W	15°	orientable	48V	482lm	90	DALI	MFLE5201344WAN	black	270,00
3000K	8W	38°	orientable	48V	633lm	90	DALI	MFLE5201744WAN	black	270,00

12W

2700K	12W	15°	orientable	48V	841lm	90	DALI	MFLE5201345DAN	black	315,00
2700K	12W	38°	orientable	48V	956lm	90	DALI	MFLE5201745DAN	black	315,00
3000K	12W	15°	orientable	48V	951lm	90	DALI	MFLE5201345WAN	black	315,00
3000K	12W	38°	orientable	48V	976lm	90	DALI	MFLE5201745WAN	black	315,00

note driver, track and accessories not included (more info on p.14-15)

IP20



SPOT 3W



SPOT 8W



SPOT 12W



OPTICS AND MOVEMENTS

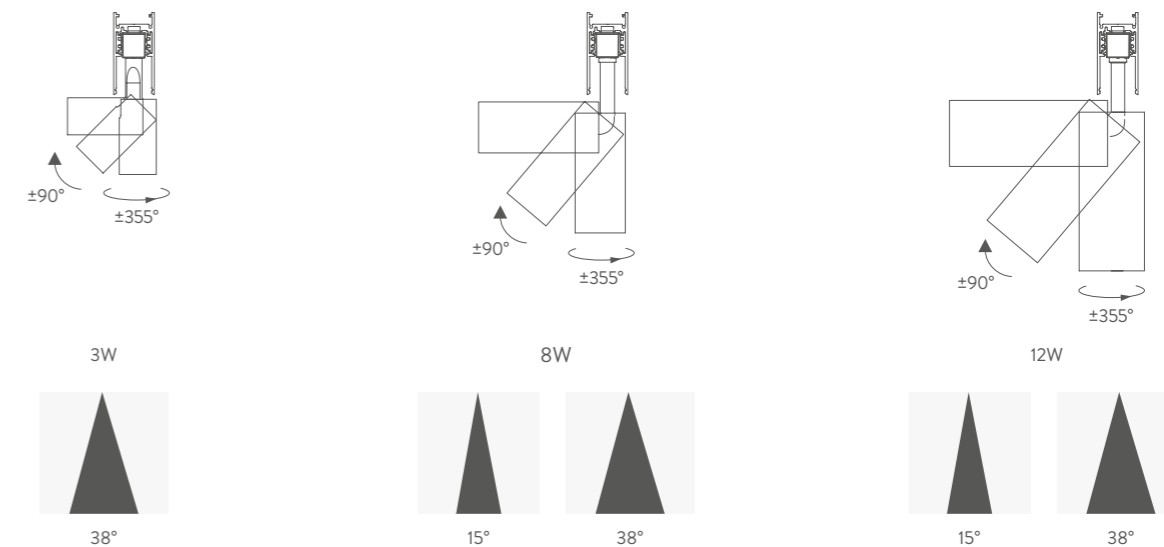

UGR LINE

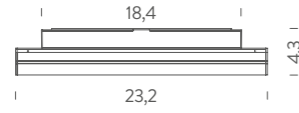

UGR FOLD

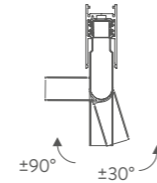
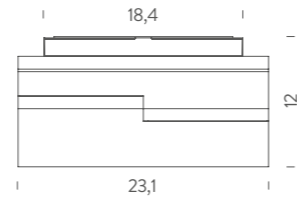

UGR LINE

CCT	max power	optic	emission	voltage	lum. flux	CRI	switching	code	finish	Euro
2700K	15W	30°	UGR<19	48V	1146lm	90	DALI	MFLE5302U48DAN	black	260,00
3000K	15W	30°	UGR<19	48V	1165lm	90	DALI	MFLE5302U48WAN	black	260,00

note driver, track and accessories not included (more info on p.14-15)

IP20

UGR FOLD

CCT	max power	optic	emission	voltage	lum. flux	CRI	switching	code	finish	Euro
2700K	20W	36°	UGR<19	48V	1397lm	90	DALI	MFLE5202T48DAN	black	315,00
3000K	20W	36°	UGR<19	48V	1550lm	90	DALI	MFLE5202T48WAN	black	315,00

note driver, track and accessories not included (more info on p.14-15)

customizations asymmetric optic

IP20



UGR LINE



UGR FOLD

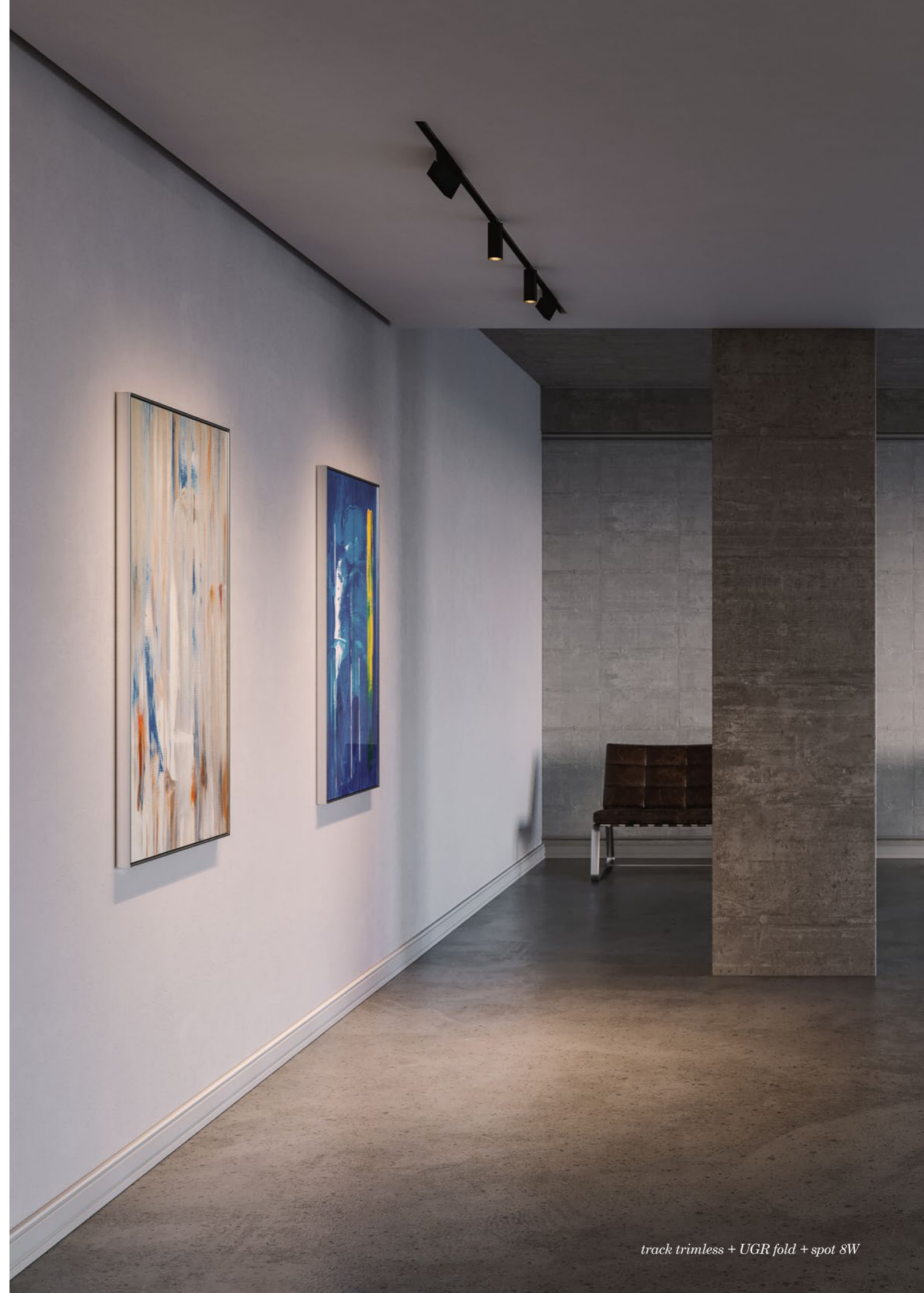

DASH 10W

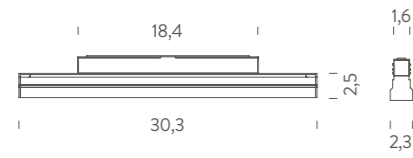

DASH 30W

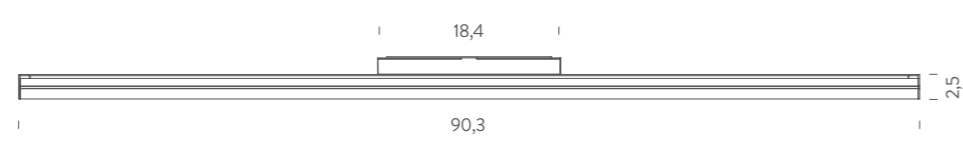
**DASH****10W**

CCT	max power	optic	emission	voltage	lum. flux	CRI	switching	code	finish	Euro
2700K	10W	112°	diffused	48V	511lm	90	DALI	MFLE5303G47DAN	black	227,00
3000K	10W	112°	diffused	48V	522lm	90	DALI	MFLE5303G47WAN	black	227,00

30W

2700K	30W	112°	diffused	48V	1530lm	90	DALI	MFLE5309G47DAN	black	305,00
3000K	30W	112°	diffused	48V	1768lm	90	DALI	MFLE5309G47WAN	black	305,00

note driver, track and accessories not included (more info on p.14-15)

 **IP20**



track trimless + dash 30W

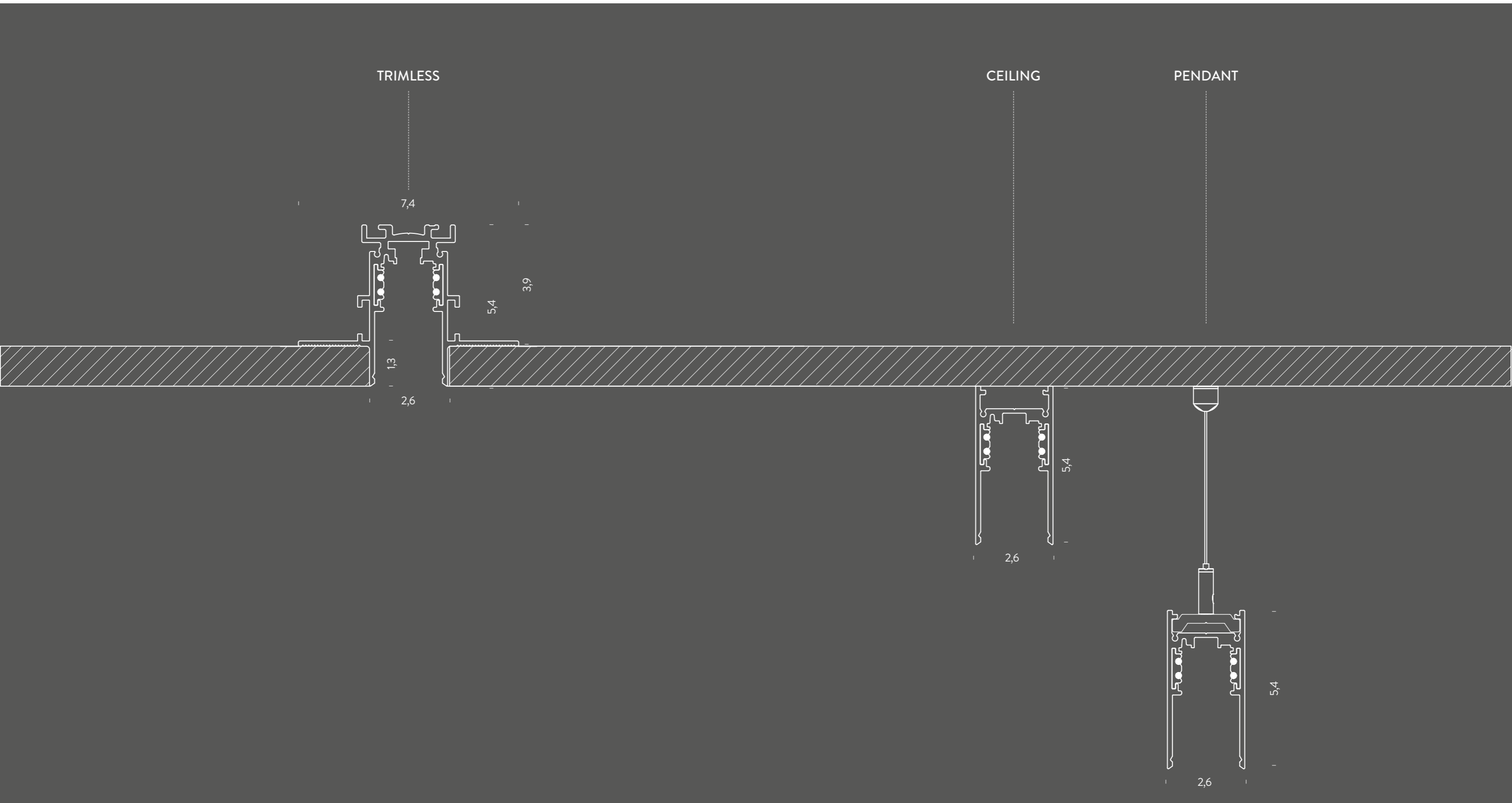

TRACK INSTALLATION SCHEME

CEILING

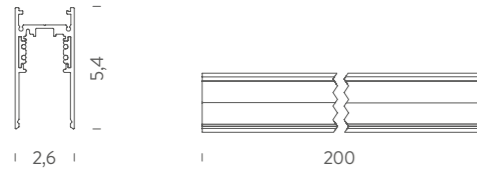

TRIMLESS

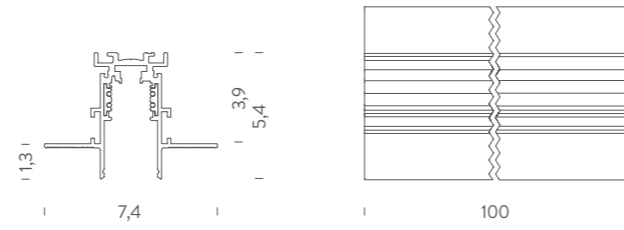

TRACK

version	voltage/current	mounting	finish	code	Euro
track 1m	48V	ceiling	black	MFLE0210NE	190,00
track 2m	48V	ceiling	black	MFLE0220NE	330,00
track 3m	48V	ceiling	black	MFLE0230NE	465,00
track 1m	48V	trimless	black	MFLE0810NE	190,00
track 2m	48V	trimless	black	MFLE0820NE	330,00
track 3m	48V	trimless	black	MFLE0830NE	465,00
<i>note</i>	pendant version available (see suspension gripper on p.15)				
<i>customizations</i>	recessed trim version				

48V
DALI - INDIVIDUAL CONTROL
OF EACH LUMINAIRE

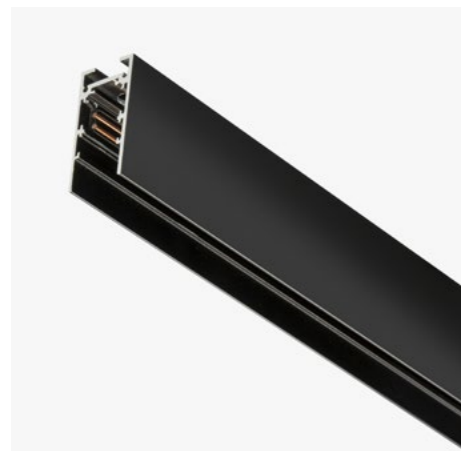

CEILING MOUNTING



TRIMLESS MOUNTING



END-CAP BLACK ALUMINUM FINISH

ACCESSORIES

version	voltage/current	mounting	finish	code	Euro
Track feeding	48V	ceiling/trimless	black	MFLEBKALIM	60,00
Track feeding joint	48V	ceiling/trimless	black	MFLEBKGIUNTOAL	35,00
Track flexible joint	48V	ceiling/trimless	black	MFLEJFONE	81,00
Ceiling track end-cap	/	ceiling/trimless	black	MFLEEND00NE	13,50
Ceiling track end-cap hole	/	ceiling/trimless	black	MFLEEND01NE	15,00
Ceiling track 90° corner	/	ceiling	black	MFLE90C00NE	94,00
Suspended Clip Alu	/	pendant/ceiling	black	MFLECL00AL	16,50
Suspension gripper + steel cable	/	pendant	black	MFLESUSP030CR	13,00
Trimless track 90° corner	/	trimless	black	MFLE90T00NE	94,00
Trimless track wall corner internal	/	trimless	black	MFLE90T01NE	94,00
Trimless track wall corner external	/	trimless	black	MFLE90T02NE	94,00
Trimless track mechanical joint	/	trimless	black	MFLEMJT00NE	13,00
Trimless track template	/	trimless	black	MFLE00TEMP	19,50

DRIVER

version	voltage/current	max power	IP	switching	code	dimensions cm	Euro
48V	IN 100/305VAC - OUT 48VDC	240W	67	on-off	WALIMLED240/48	22x6,5x3,5	270,00
wireless	/	/	/	CASAMBI PUSH	WBLTDEVICE	4,4x1,9x5,7	220,00
note	WBLTDEVICE iOS and Android compatible, set up by customer or by Nemo Studio upon request						

COMPATIBLE WITH CEILING AND TRIMLESS TRACK

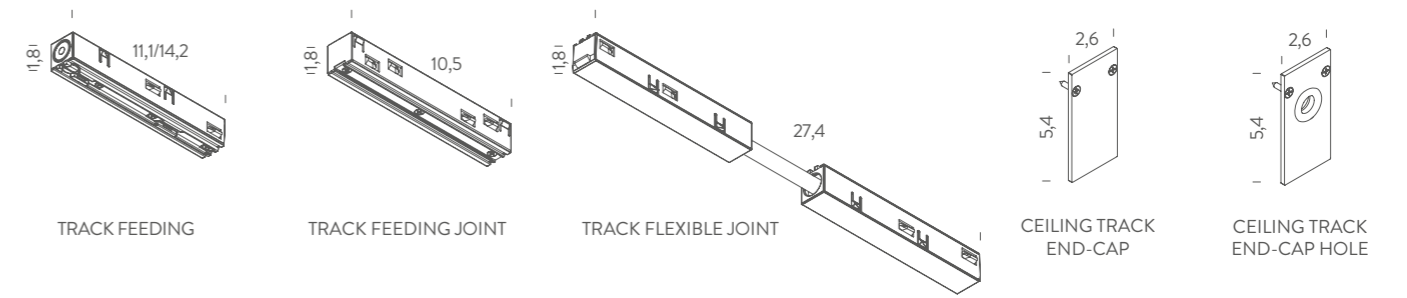

COMPATIBLE WITH CEILING TRACK

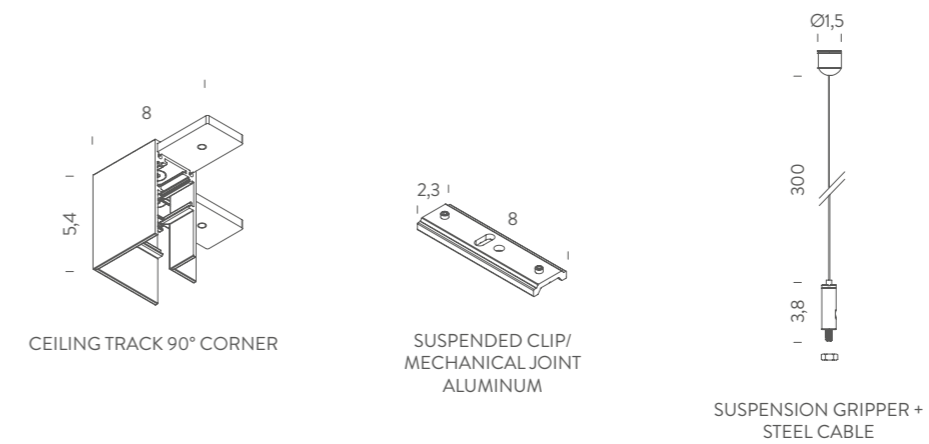

COMPATIBLE WITH TRIMLESS TRACK

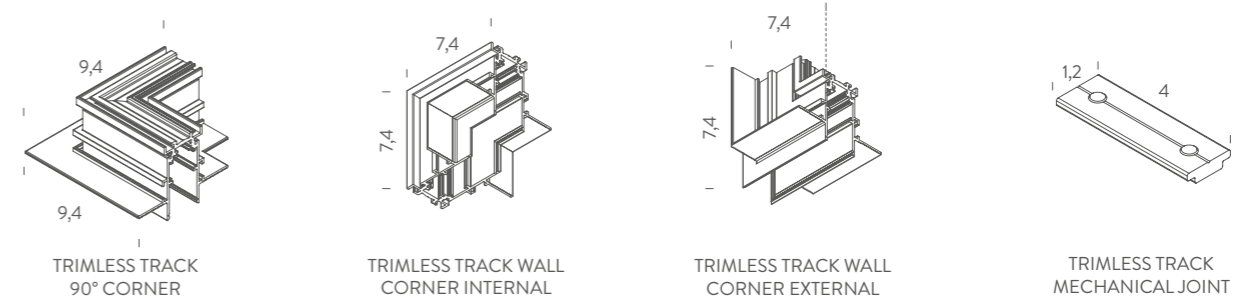



track trimless + dash 30W

track ceiling + spot 8W + dash 30W

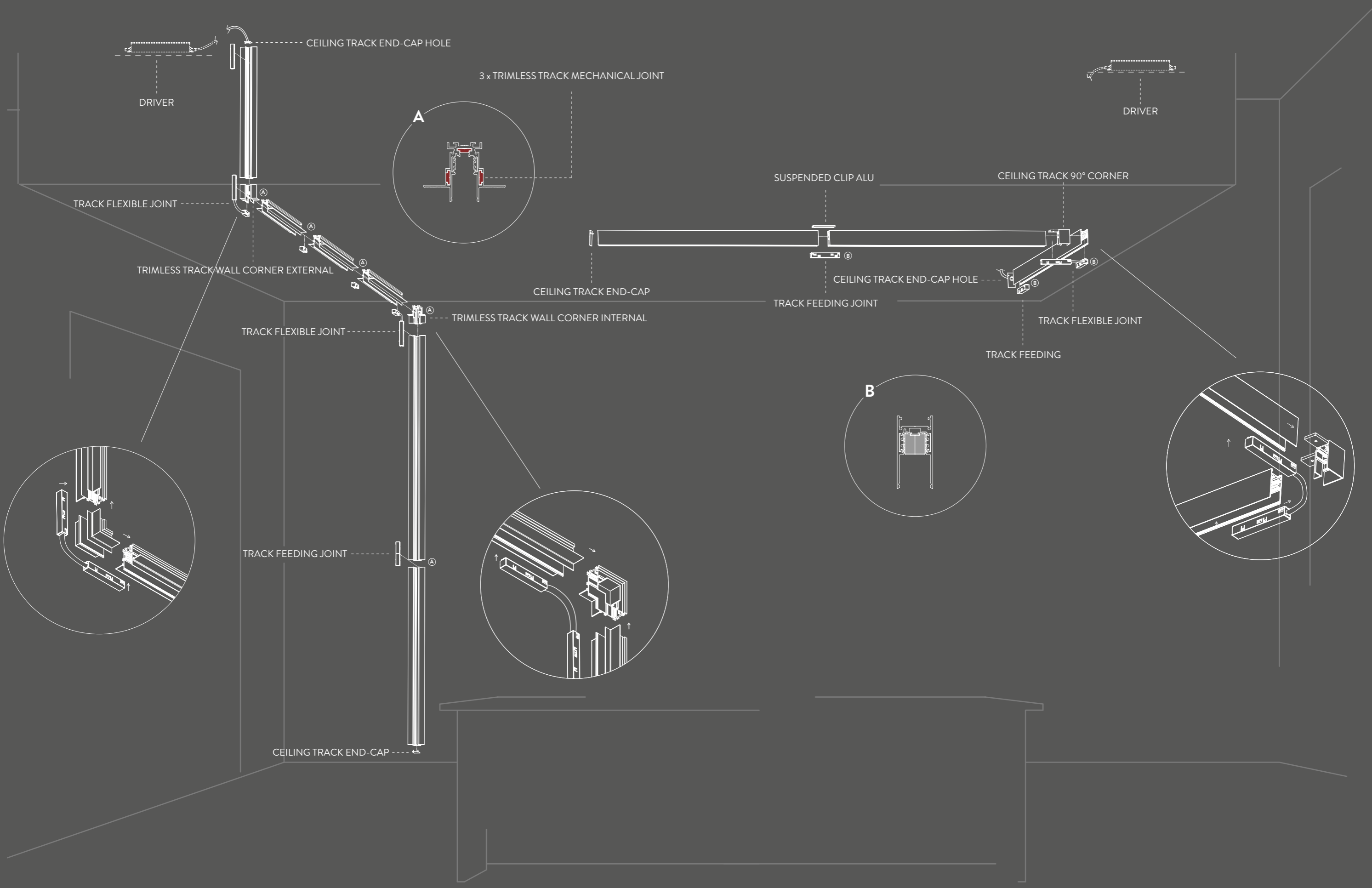



track trimless + dash 30W

track pendant + spot 8W + spot 3W + UGR line

SUMMING UP

SPOT

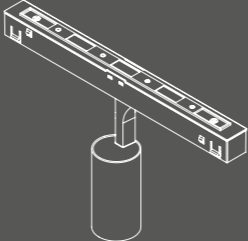

SPOT 3W

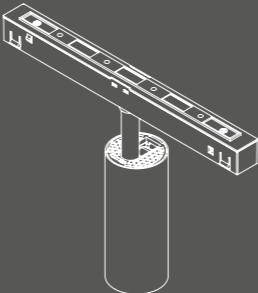

SPOT 8W

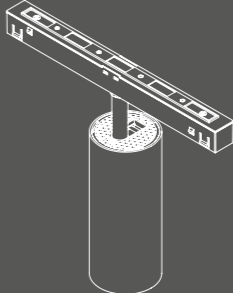

SPOT 12W

UGR

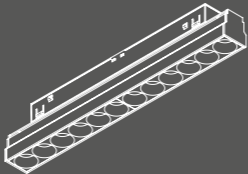

UGR LINE

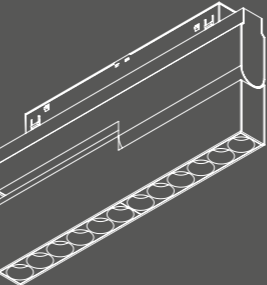

UGR FOLD

DASH

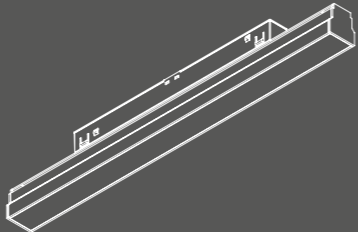

DASH 10W

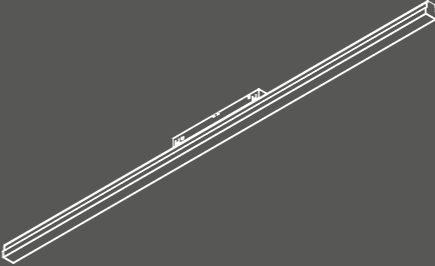

DASH 30W

TRACK

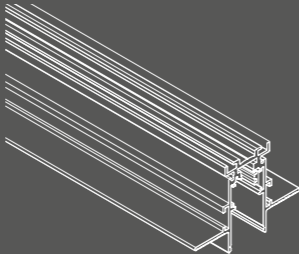

TRIMLESS

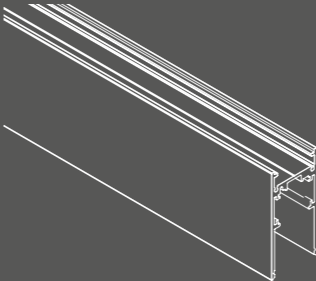

CEILING

GENERAL INFORMATION

Obiettivo di Nemo e Nemo Studio è quello di proporre soluzioni tecnologiche all'avanguardia, anche tramite un continuo e costante processo di aggiornamento. Per definizione la tecnologia è mutevole ed in costante evoluzione. Sugeriamo, per assicurare la consultazione delle informazioni più recenti sui prodotti, di verificare quelle disponibili sul nostro sito www.nemolighting.com. Questo documento è stato redatto a Aprile 2022. Sostituisce ed aggiorna qualsiasi altra pubblicazione in relazione ai prodotti elencati.

Nemo and Nemo Studio's goal is to propose cutting-edge technological solutions, also through a constant updating process. By definition, technology is changing and continuously evolving. To ensure the consultation of the latest product data, we recommend referring to the information available on our website www.nemolighting.com. This document was drafted in April 2022. It replaces and updates any other publication in relation to the listed products.

Das Ziel von Nemo und Nemo Studio ist die Entwicklung von technologischen Lösungen auf dem neuesten Stand, auch durch einen ständigen Aktualisierungsprozess. Die Technik entwickelt sich ständig weiter. Um die aktuellsten Produktunterlagen einzusehen, empfehlen wir, sich auf die Informationen auf unserer Website www.nemolighting.com zu beziehen. Dieses Dokument wurde im April 2022 verfasst. Es ersetzt und aktualisiert alle anderen Veröffentlichungen in Bezug auf die aufgeführten Produkte.

L'objectif de Nemo et Nemo Studio est de proposer des solutions technologiques de pointe, également à travers un processus de mise à jour constante. Par définition, la technologie évolue et change continuellement. Ce document a été rédigé en Avril 2022. Pour garantir la consultation des dernières données produits, nous vous recommandons de vous référer aux informations disponibles sur notre site www.nemolighting.com. Remplace et met à jour toute autre publication en relation avec les produits listés.

This document supersedes and updates all previous catalogues and publications in relation to the products listed here in.

Questa pubblicazione sostituisce ed aggiorna i precedenti cataloghi con riferimento ai prodotti elencati.



The updated list of UL and ETL marked products and relevant technical information are available on the website: nemolighting.com/usa/

NEMO | NEMO STUDIO

NEMO HEAD OFFICE

Viale Brianza, 30,
20823 Lentate s/S - ITALY
Tel +39 0362 166 050 0
info@nemolighting.com

NEMO STUDIO

Strada Borgata Paradiso, 20
10036 Settimo Torinese - ITALY
Tel. +39 011 765 73 01
nemostudio@nemolighting.com

SHOWROOM MILANO

Corso Monforte 19/A,
20122 Milan
Tel +39 02 970 703 40
monforte@nemolighting.com

NEMO GALLERY MILANO

Via Borgonuovo 19,
20121 Milan
studio@nemolighting.com

NEMO FRANCE | NEMO GALERIE PARIS

44, Rue du Bac
75007 Paris
Tel +33 (0) 1 40 20 47 69
Tel +33 (0) 1 48 6 300 77
ruedubac@nemolighting.fr
france@nemolighting.fr
nemolighting.com/fra/

NEMO USA

625 Jersey Avenue, Unit 7
New Brunswick, NJ 08901
Tel 800 734 5858
usa@nemolighting.com
nemolighting.com/usa/

Scan the code for Terms and Conditions



For more info visit our website

