

# G3 PRO



## ENHANCED CIRCULAR RECESSED DOWNLIGHTERS

IP20 ABOVE CEILING IP40 BELOW CEILING



### SPECIFICATION

- High pressure die-cast ring finished full polyester non-yellowing satin white (RAL 9016)
- High performance vacuum metalized inner reflector with wide or narrow distribution options
- Choice of white or anti-glare black injection moulded flame-retardant outer reflector for dynamic appearance
- Excellent glare control at 50° and above
- Optional reinforcing board with centre cut aperture
- Smart versions with intelligent lighting control
- SmartScan wireless technology removes the need for control cabling. Ideal for retro-fit
- Emergency and AutoTest versions
- Supplied with remote gear unit fitted with 2m lead
- Smart/SmartScan versions fitted with TEE connector for LCM wiring
- CRI 90 LEDs with enhanced R9 value available to special order
- Fitted with 3000K/4000K LEDs

### LED CHARACTERISTICS

CRI	80+
COLOUR TEMPERATURE	3000K/4000K
RATED LIFE (HOURS)	50K - L70/B10
PROTECTION	-
DRIVER EFFICIENCY	>80%
REPLACEABLE	YES
POWER FACTOR	>0.9
<b>LL/CW</b>	<b>121.4</b>

For LED characteristics explanation see [www.thorlux.com/led-guide](http://www.thorlux.com/led-guide)

**WEB LINK >**  
"PLUG AND PLAY"  
LIGHTING CABLE  
MANAGEMENT



### SmartScan Configurations



Find out more at [www.thorlux.com/smartsan](http://www.thorlux.com/smartsan)

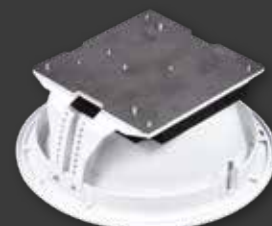

Body and heat sink -  
11W and 24W versions



Remote Smart Sensor



Body and heat sink -  
51W version

# G3 PRO

## RANGE



	LED	3000K	4000K	APPROX. kg	CIRCUIT	
WHITE OUTER REFLECTOR	SMART	Broad distribution				
		11W	GT 19380	GT 19384	1.3	D/SS
		24W	GT 19381	GT 19385	1.3	D/SS
		51W	GT 19382	GT 19386	2.1	D/SS
		Narrow distribution				
	51W	GT 19383	GT 19387	2.1	D/SS	
	STANDARD	Broad distribution				
		11W	GT 19388	GT 19392	0.6	L/A
		24W	GT 19389	GT 19393	0.6	L/A
		51W	GT 19390	GT 19394	1.4	L/A
Narrow distribution						
51W	GT 19391	GT 19395	1.4	L/A		
BLACK OUTER REFLECTOR	SMART	Broad distribution				
		11W	GT 19396	GT 19400	1.3	D/SS
		24W	GT 19397	GT 19401	1.3	D/SS
		51W	GT 19398	GT 19402	2.1	D/SS
		Narrow distribution				
	51W	GT 19399	GT 19403	2.1	D/SS	
	STANDARD	Broad distribution				
		11W	GT 19404	GT 19408	0.6	L/A
		24W	GT 19405	GT 19409	0.6	L/A
		51W	GT 19406	GT 19410	1.4	L/A
Narrow distribution						
51W	GT 19407	GT 19411	1.4	L/A		

CIRCUIT TYPE - suffix catalogue number with:

**SMART** D - Smart / SS - SmartScan

**STANDARD** L - non-dimming (LED) / A - dimming (DALI) e.g. GT 19380SS etc.

EMERGENCY VERSION - prefix catalogue number with:

**EGT** - Emergency (Not available when selecting the 'SS' suffix)

**TGT** - AutoTest

**WGT** - SmartScan (Only available when selecting the 'SS' suffix)

e.g. **WGT 19380SS** etc.

Add 0.9kg to weights listed or add 0.3kg for Smart versions.

CRI 90 VERSIONS - suffix catalogue number with:

**C930** - 3000K / **C940** - 4000K e.g. **GT 19380SSC930** etc.

## ACCESSORIES

DESCRIPTION	CAT. No.	APPROX. kg
597 x 597mm ceiling reinforcing board (3mm thick plywood with 185mm diameter central cut-out)	<b>GT 11970</b>	0.55

## PHOTOMETRIC GUIDE

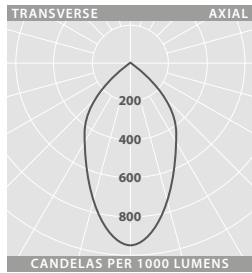

### BROAD DISTRIBUTION WHITE OUTER REFLECTOR

LED	3000K (lm)	4000K (lm)
11W	1580	1700
24W	3030	3260
51W	5285	5685

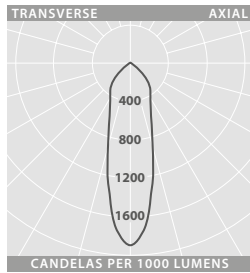

### NARROW DISTRIBUTION WHITE OUTER REFLECTOR

LED	3000K (lm)	4000K (lm)
51W	5460	5870

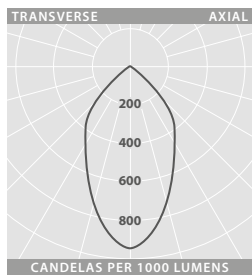

### BROAD DISTRIBUTION BLACK OUTER REFLECTOR

LED	3000K (lm)	4000K (lm)
11W	1570	1690
24W	3010	3235
51W	5255	5650

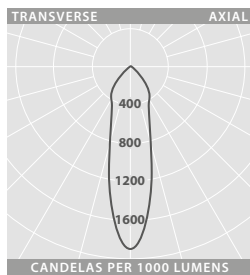

### NARROW DISTRIBUTION BLACK OUTER REFLECTOR

LED	3000K (lm)	4000K (lm)
51W	5415	5825

## DIMENSIONS

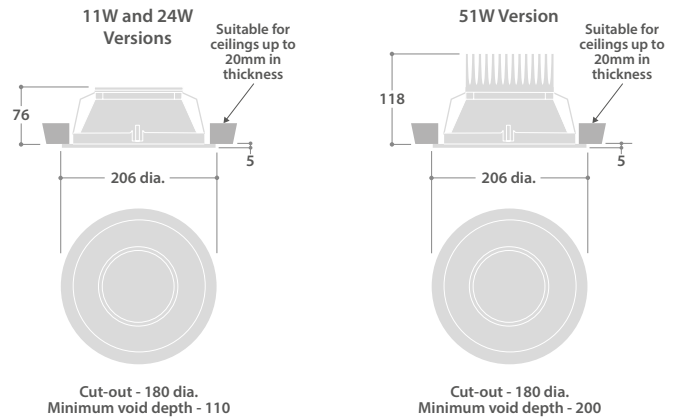

### Standard Remote Driver

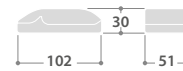

### LED Downlighter Power Unit



- 1 LED Downlighter Power Unit for SmartScan, Smart, Emergency and AutoTest versions.
- 2 Remote Driver for standard versions