

G3



ACTUAL SIZE



CIRCULAR LED RECESSED DOWNLIGHTERS

IP20 ABOVE CEILING

IP40 BELOW CEILING

IP65 BELOW CEILING (IP65 version only)



SPECIFICATION

- High pressure die-cast ring finished full polyester non-yellowing satin white (RAL 9016)
- Injection moulded reflector finished white
- Toughened/safety drop glass attachments provide a measure of light on the ceiling
- Optional reinforcing board with centre cut aperture
- SmartScan Radar versions with sensor discretely hidden behind the cover
- Emergency and AutoTest versions
- Supplied with remote gear unit fitted with 2m supply lead
- SmartScan Radar versions fitted with TEE connector for LCM wiring
- CRI 90 option available to special order
- Fitted with 3000K/4000K LEDs



LED CHARACTERISTICS

CRI	80+
COLOUR TEMPERATURE	3000K/4000K
RATED LIFE (HOURS)	100K - L80/B10
PROTECTION	LUX GUARD
DRIVER EFFICIENCY	>85%
REPLACEABLE	YES
POWER FACTOR	>0.9
LL/CW	121.5

For LED characteristics explanation see www.thorlux.com/led-guide

SmartScan Radar Configurations



Find out more at www.thorlux.com/smartsan

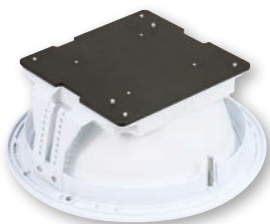

Body and heat sink







- 1 Remote Driver for standard versions
- 2 Downlighter Power Unit for Emergency and AutoTest versions.



- 3 SmartScan Radar Power Unit for SmartScan Radar and SmartScan Radar Emergency versions (Emergency version shown).

RANGE

	LED	3000K	4000K	APPROX. kg	CIRCUIT
	8W	GT 18387	GT 15070	0.8	L/A/R
	16W	GT 18388	GT 15071	0.8	L/A/R
	21W	GT 18389	GT 18371	0.8	L/A
	8W	GT 18392	GT 15073	1.2	L/A/R
	16W	GT 18393	GT 15074	1.2	L/A/R
	21W	GT 18394	GT 18373	1.2	L/A
	8W	GT 18397	GT 15076	1.3	L/A/R
	16W	GT 18398	GT 15077	1.3	L/A/R
	21W	GT 18399	GT 18375	1.3	L/A
	8W	GT 18402	GT 15079	0.9	L/A/R
	16W	GT 18403	GT 15080	0.9	L/A/R
	21W	GT 18404	GT 18377	0.9	L/A
	8W	GT 18405	GT 15082	1.0	L/A/R
	16W	GT 18406	GT 15083	1.0	L/A/R
	21W	GT 18407	GT 18378	1.0	L/A
	Clear glass versions				
	8W	GT 18411	GT 15085	1.2	L/A/R
	16W	GT 18412	GT 15086	1.2	L/A/R
	21W	GT 18413	GT 18382	1.2	L/A
	Frosted glass versions				
	8W	GT 18414	GT 15088	1.2	L/A/R
	16W	GT 18415	GT 15089	1.2	L/A/R
	21W	GT 18416	GT 18383	1.2	L/A
	Clear polycarbonate versions				
8W	GT 18417	GT 15091	1.2	L/A/R	
16W	GT 18418	GT 15092	1.2	L/A/R	
21W	GT 18419	GT 18384	1.2	L/A	

CIRCUIT TYPE - suffix catalogue number with:

L - non-dimming (LED) / **A** - dimming (DALI) / **R** - SmartScan Radar e.g. **GT 18387L** etc.
SmartScan Radar add 0.1kg to weights listed.

EMERGENCY VERSION - prefix catalogue number with:

EGT - Emergency (Not available when selecting the 'R' suffix)
TGT - AutoTest

WGT - SmartScan (Not available when selecting the 'A' suffix)
e.g. **WGT 18387L** etc.

Add 0.9kg to weights listed.

PHOTOMETRIC GUIDE

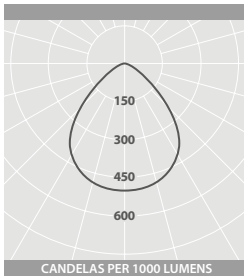

OPEN

LED	3000K (lm)	4000K (lm)
8W	1140	1215
16W	2075	2210
21W	2620	2790

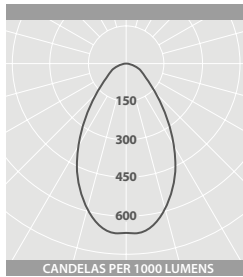

FROSTED OUTER

LED	3000K (lm)	4000K (lm)
8W	985	1050
16W	1790	1905
21W	2260	2410

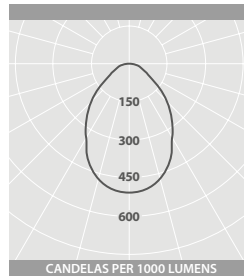

FROSTED INNER

LED	3000K (lm)	4000K (lm)
8W	940	1000
16W	1715	1825
21W	2165	2305

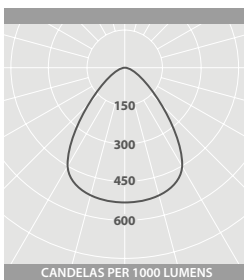

HALO

LED	3000K (lm)	4000K (lm)
8W	1095	1165
16W	1985	2115
21W	2505	2670

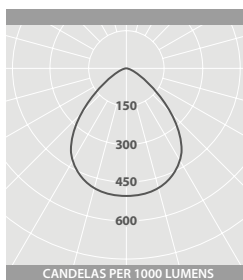

IK10

LED	3000K (lm)	4000K (lm)
8W	1030	1095
16W	1870	1990
21W	2360	2515

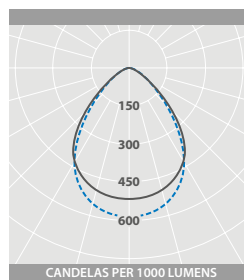

IP65

LED	3000K (lm)	4000K (lm)
8W Clear Glass	1050	1120
16W Clear Glass	1910	2035
21W Clear Glass	2410	2565
8W Polycarbonate	925	985
16W Polycarbonate	1685	1795
21W Polycarbonate	2125	2265
8W Frosted Glass	1000	1065
16W Frosted Glass	1820	1940
21W Frosted Glass	2300	2450

DIMENSIONS

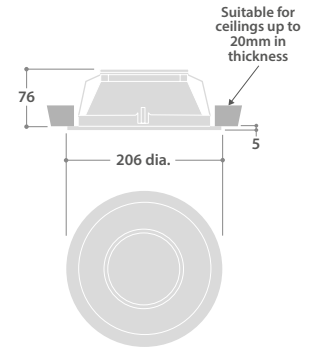

Cut-out - 180 dia.
Minimum void depth - 110

Standard Remote Driver

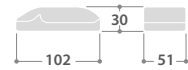

Downlighter Power Unit

for SmartScan Radar, SmartScan Radar Emergency, Emergency and AutoTest versions



ACCESSORIES

DESCRIPTION	CAT. No.	APPROX. kg
Retro-fit fixing kit <i>(for fitting drop glass attachments only to undrilled bezels)</i>	GT 11643	0.01
Matt chrome cone head screw - 3 off <i>(for drop glass versions)</i>	GT 11866	0.02
Matt chrome slotted head screw - 3 off <i>(for drop glass versions)</i>	GT 11867	0.02
Matt chrome knurled head screw - 3 off <i>(for drop glass versions)</i>	GT 11868	0.02
597 x 597mm ceiling reinforcing board <i>(3mm thick plywood with 185mm diameter central cut-out)</i>	GT 11970	0.55



Cone Head



Slotted Head



Knurled Head

WEB LINK >
"PLUG AND PLAY"
LIGHTING CABLE
MANAGEMENT

